

Canopy - 4mm Bals

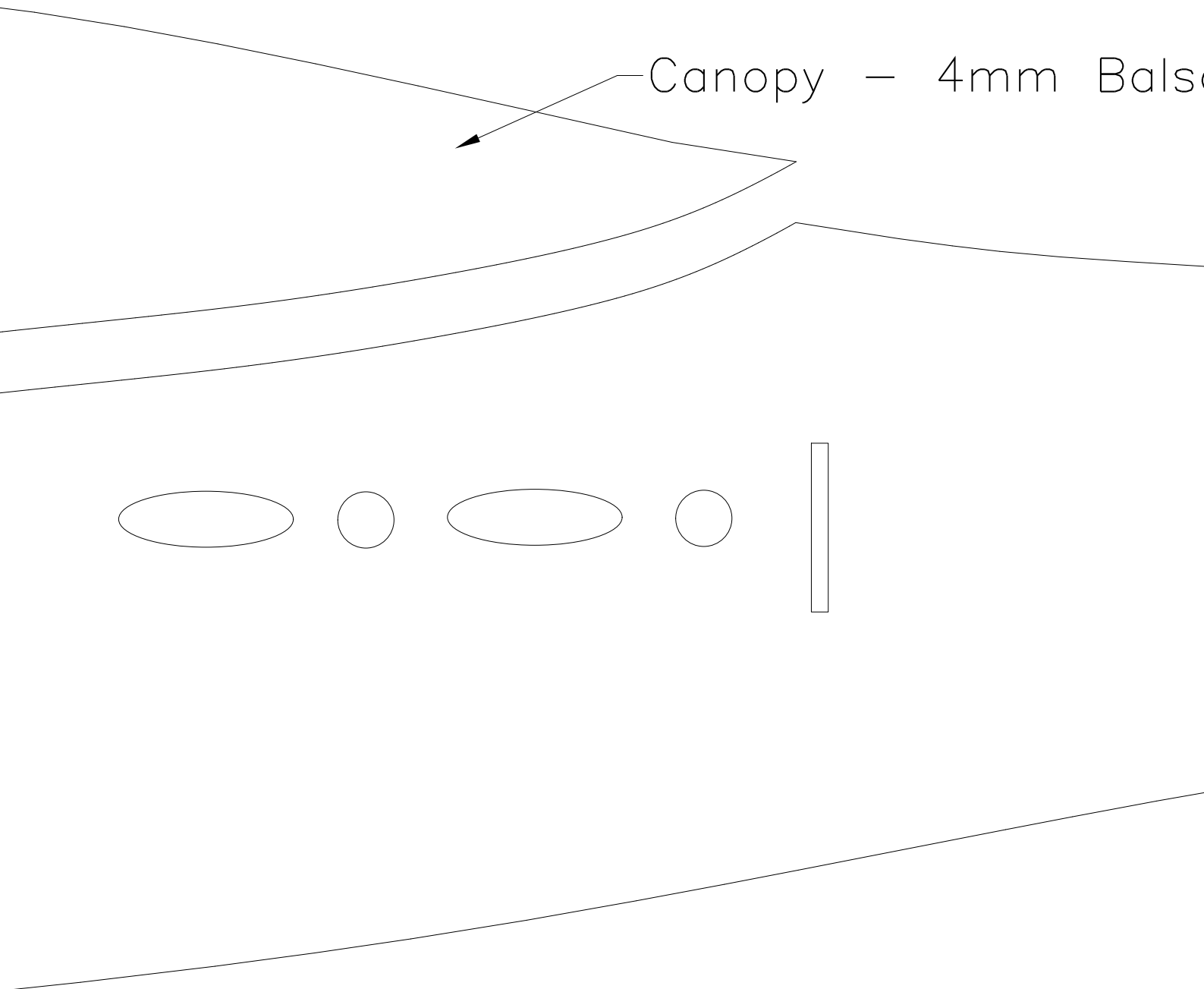

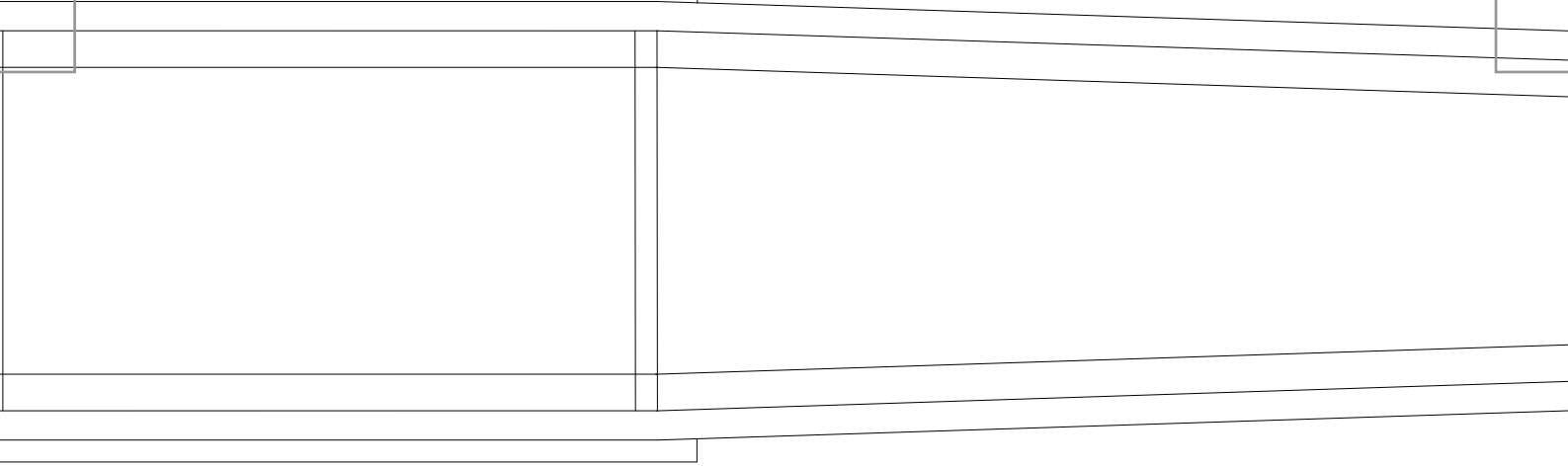

Balsa

Fuselage —

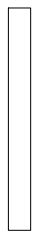
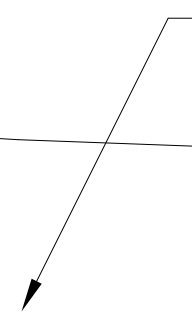

— 4mm Balsa



T2



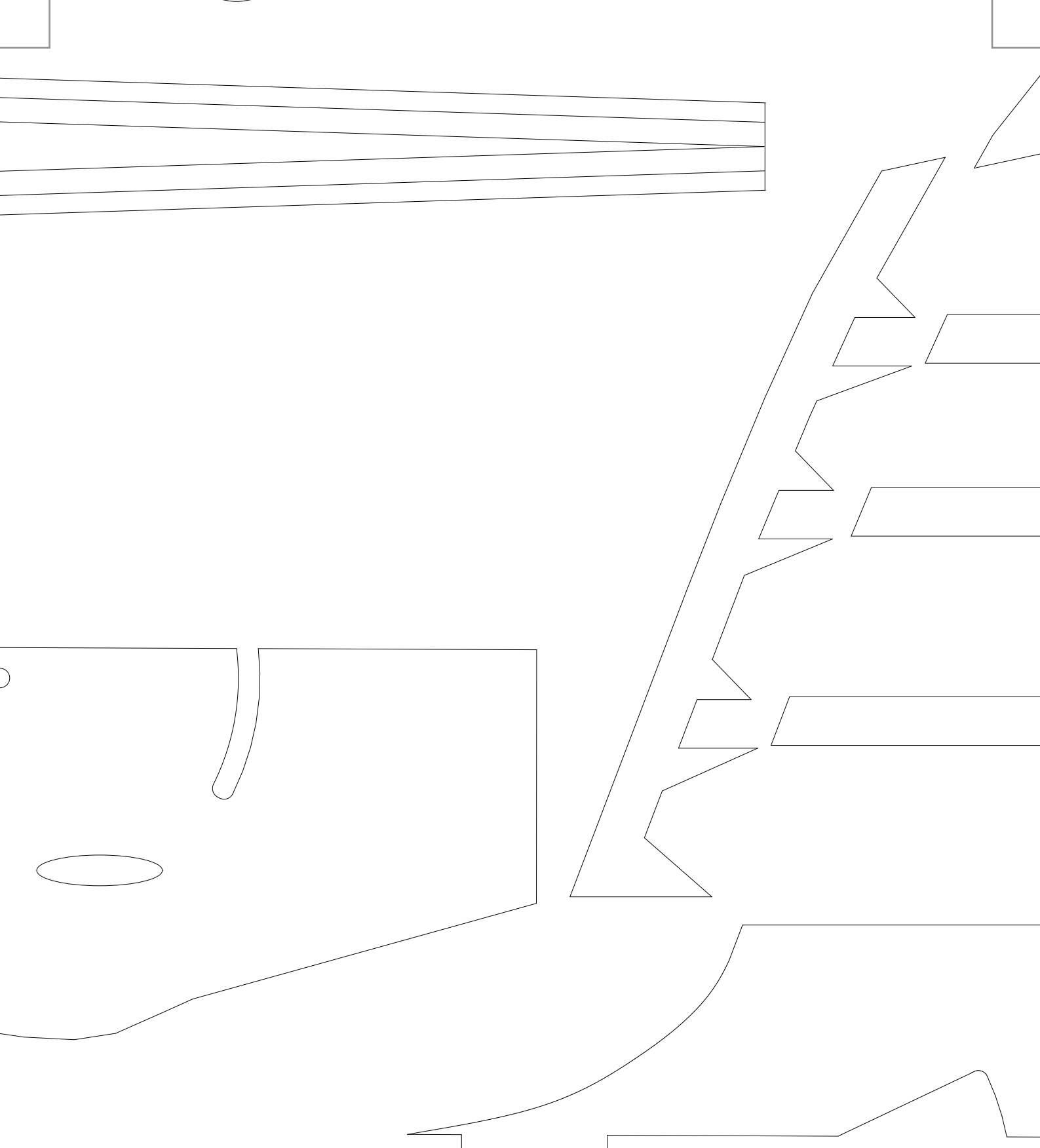

Rudder – All parts in 5m

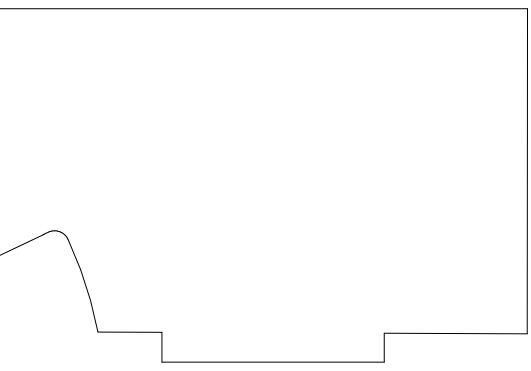
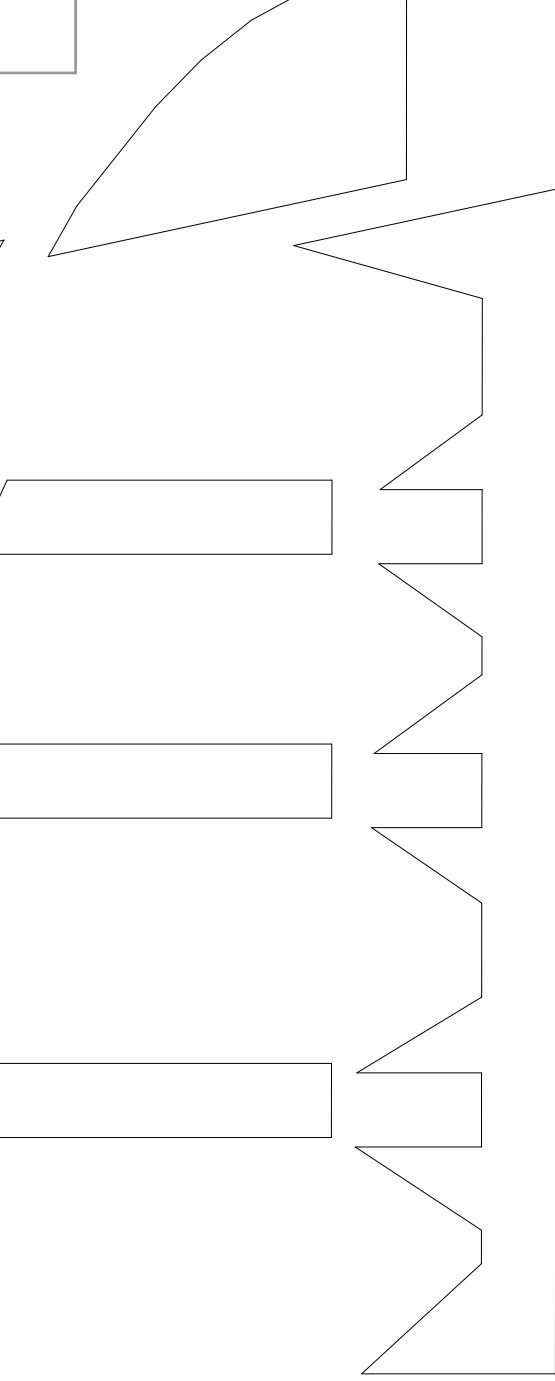

5mm Balsa

Balsa Block

C1

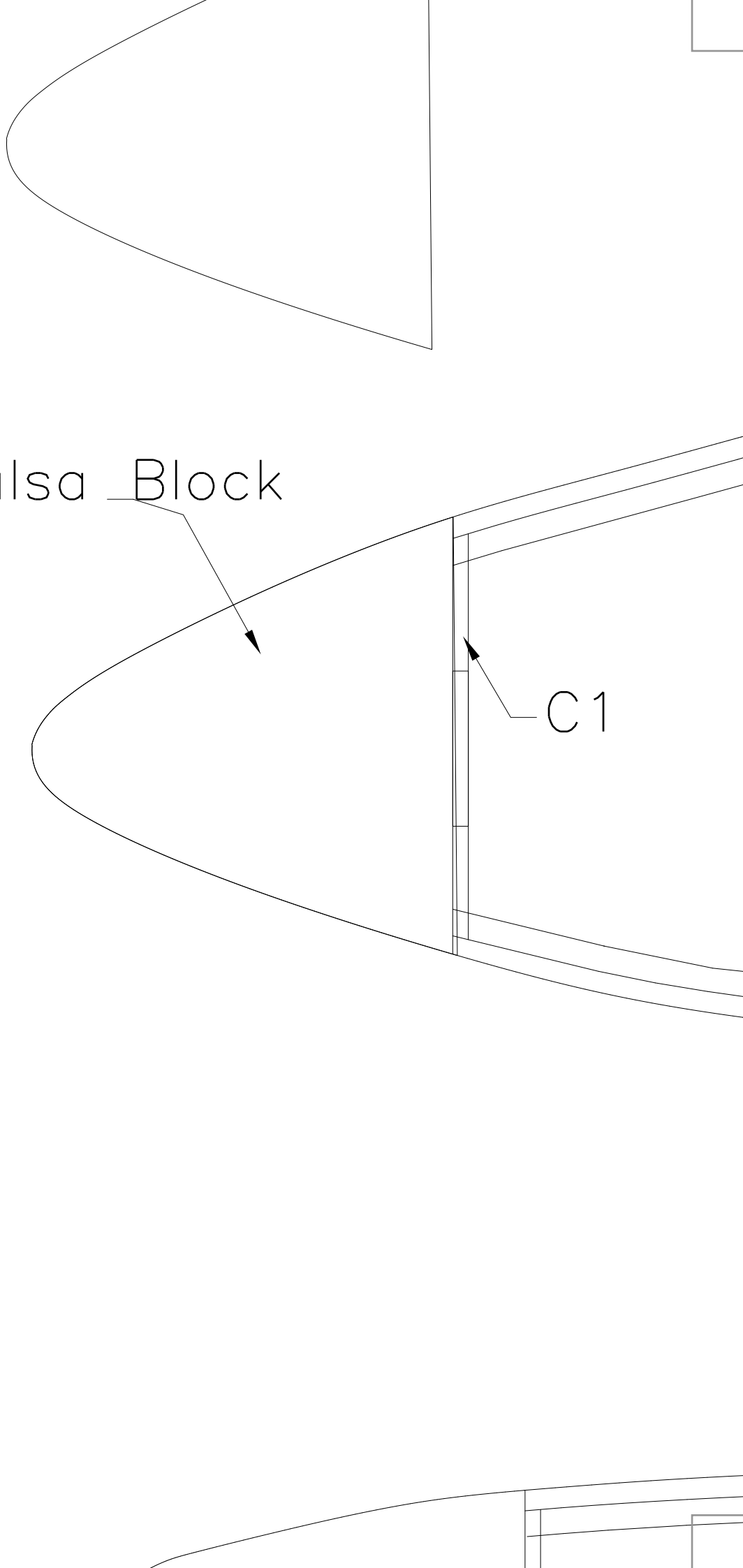

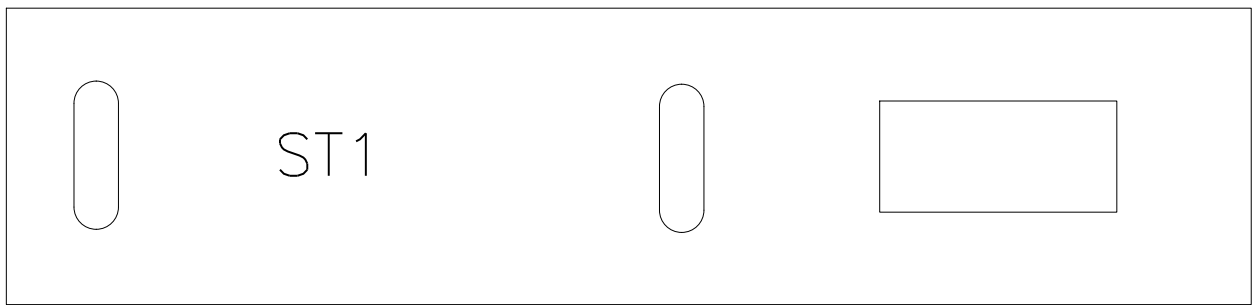
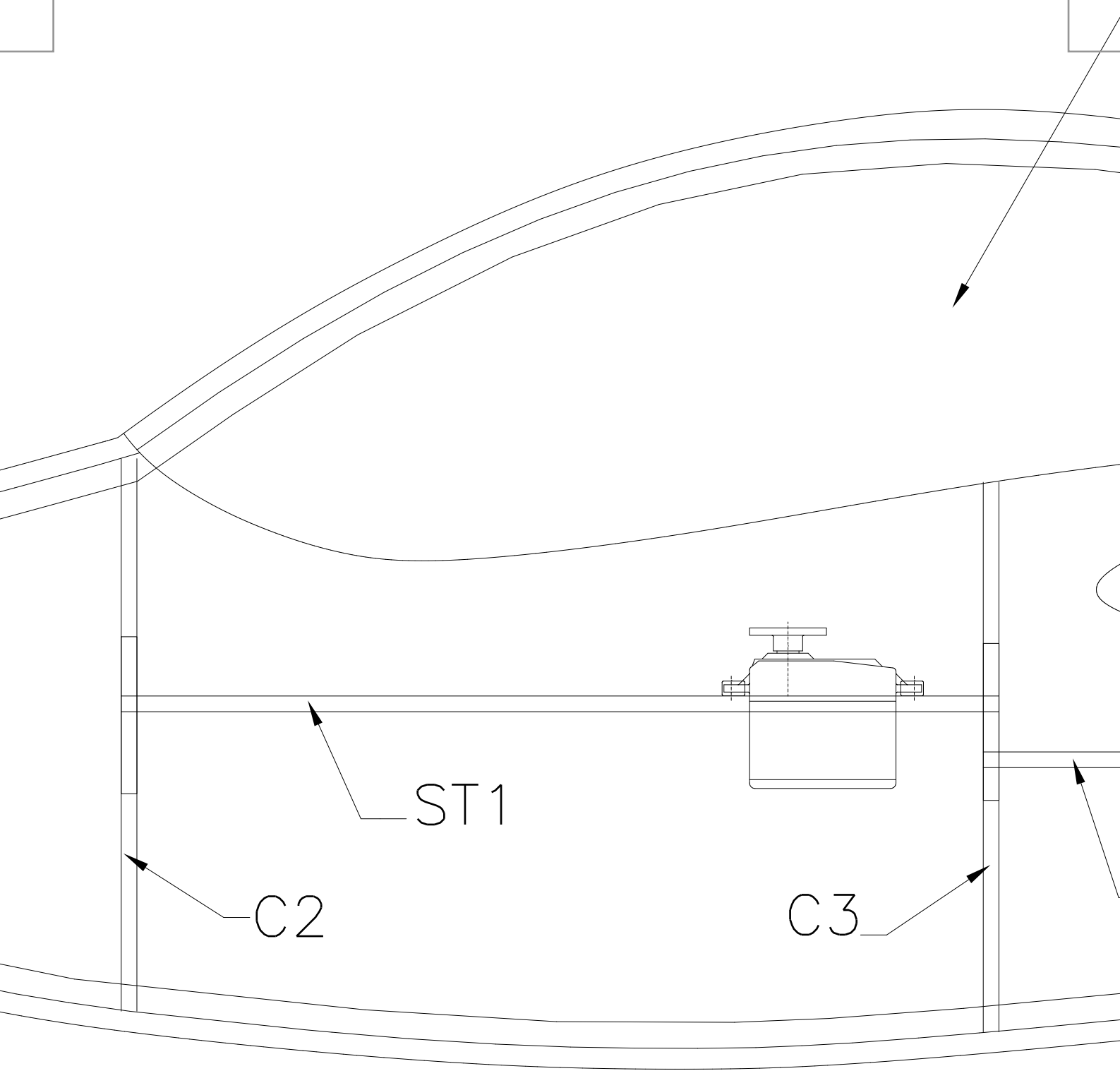

Fuselage servo tray -

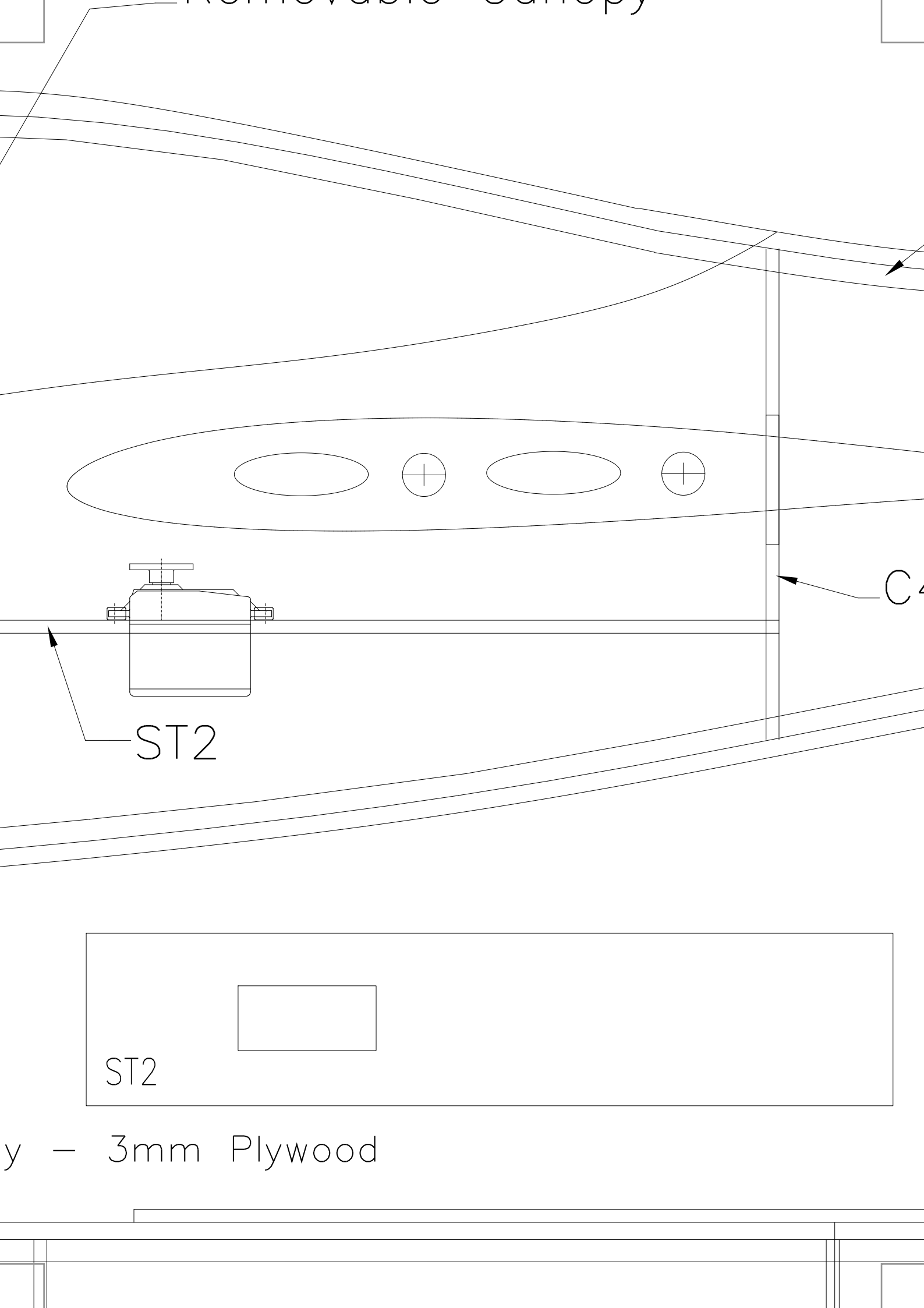

C1

Balsa Strips — 5x5mm

C4

C5

T2

3mm Balsa

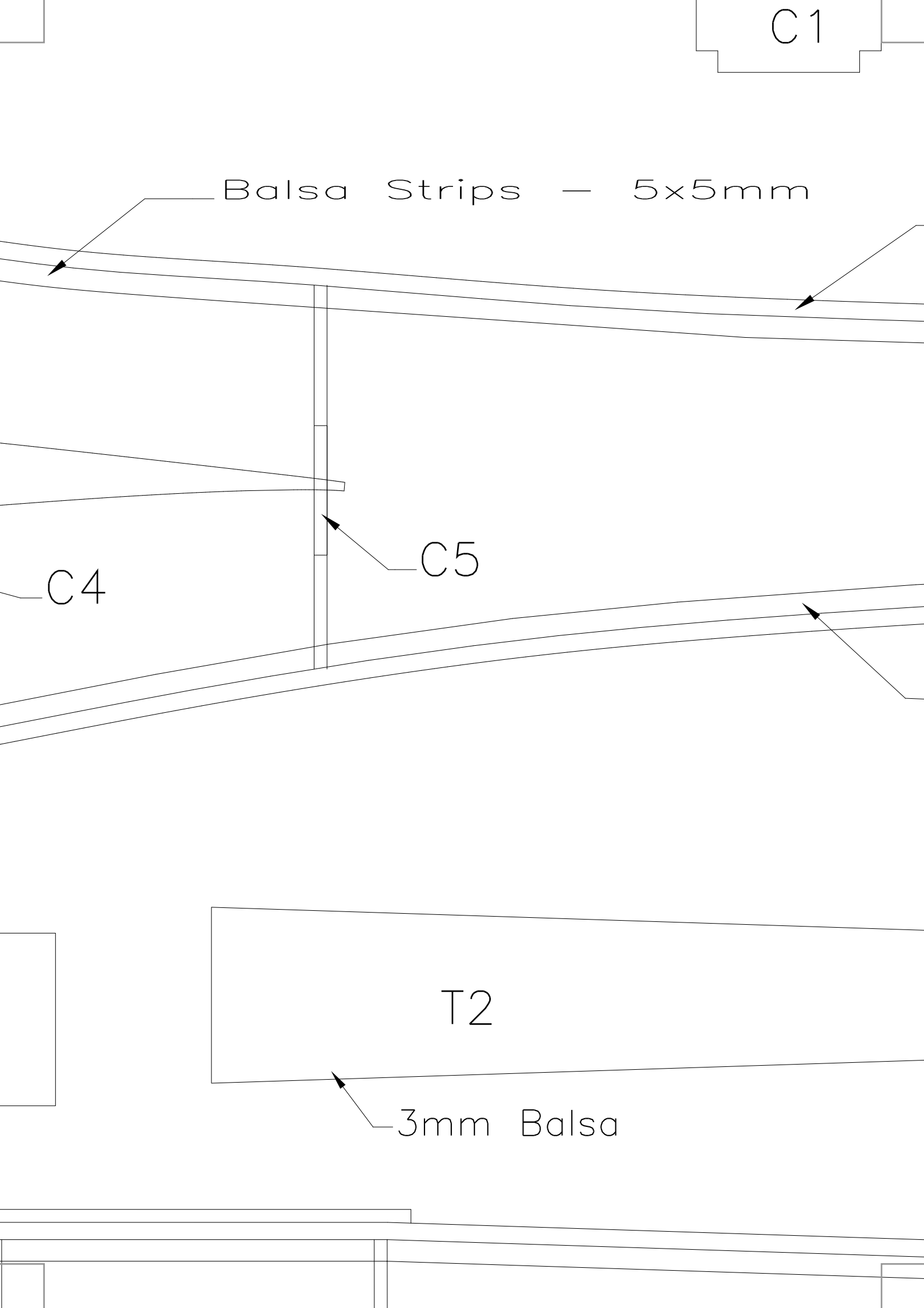

C4

Balsa 4mm

ALL formers in 3m

C6

Balsa Strips - 5x5mm

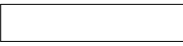
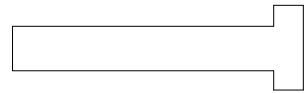
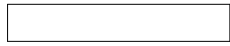

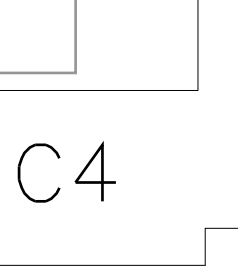

C4

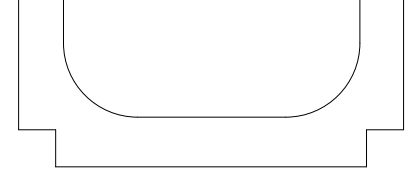

3mm Plywood



T1 - 3mm Plywood

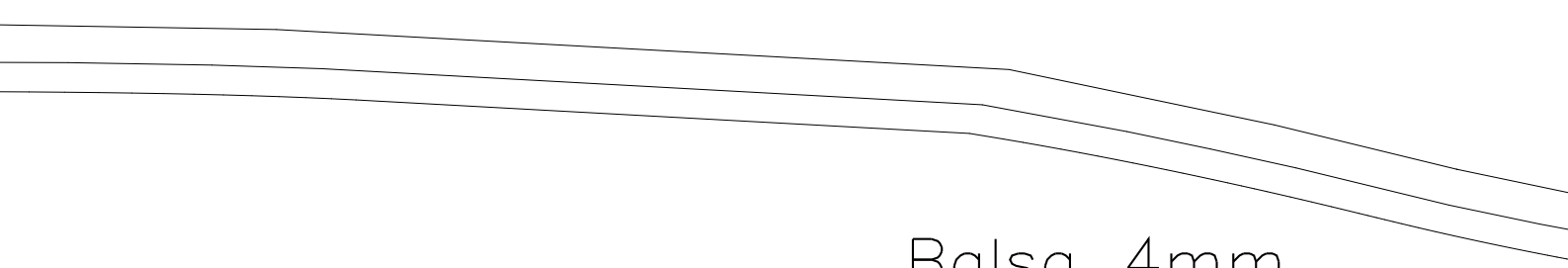

Balsa 4mm

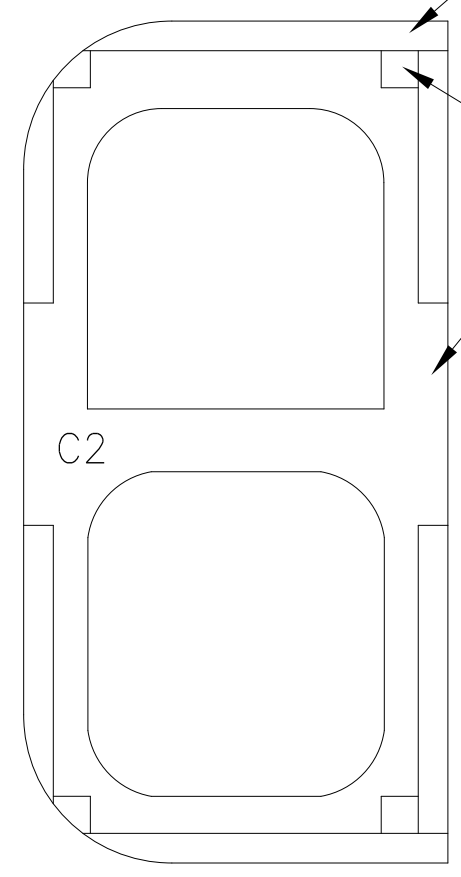

C2

5x5mm Balsa

Former

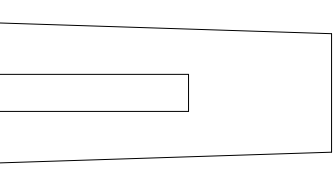

3mm Plywood

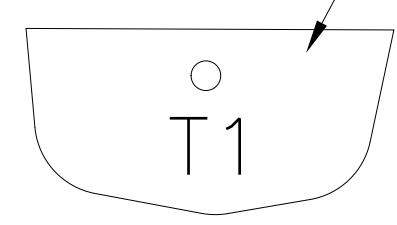

T1

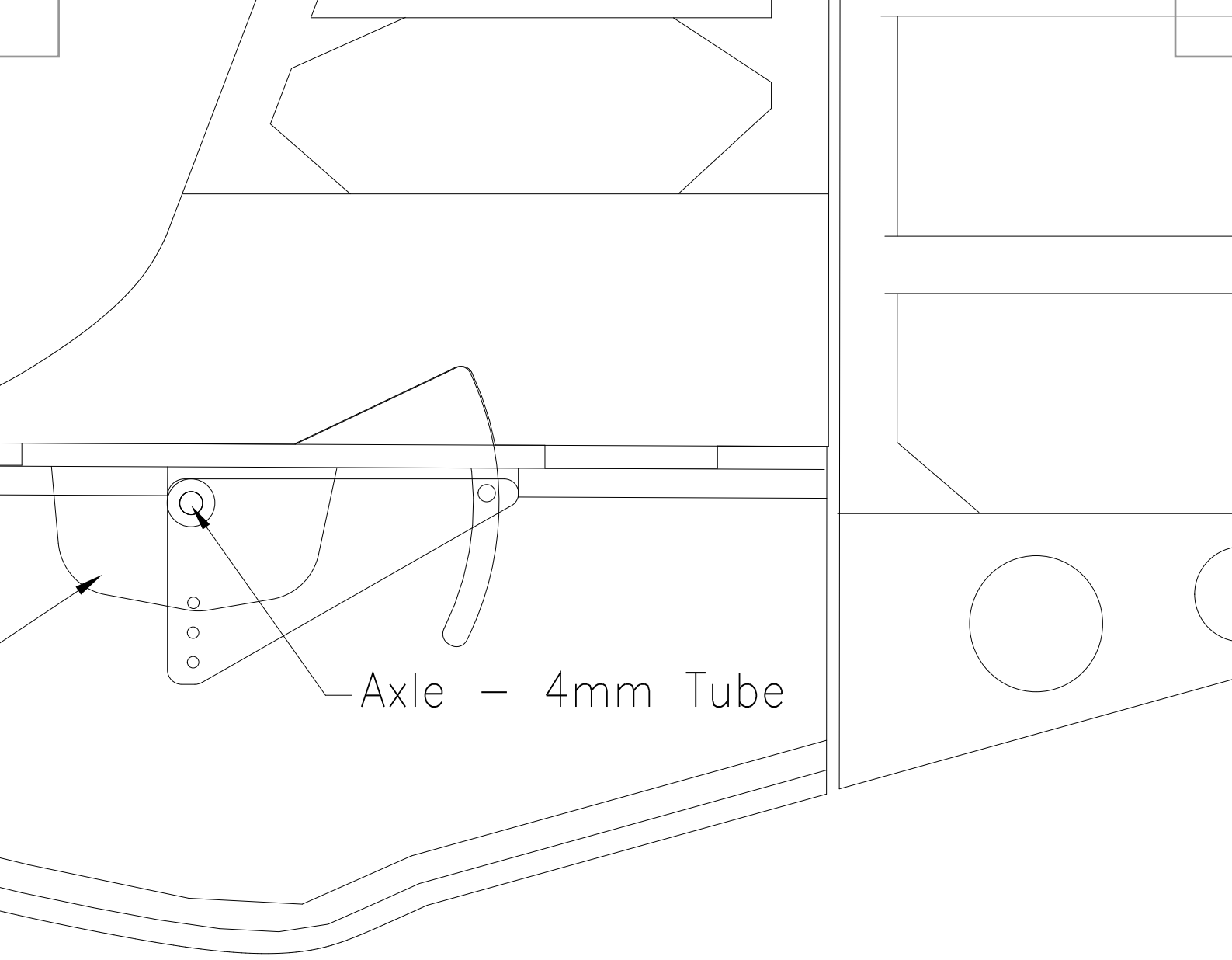

Axle - 4mm Tube

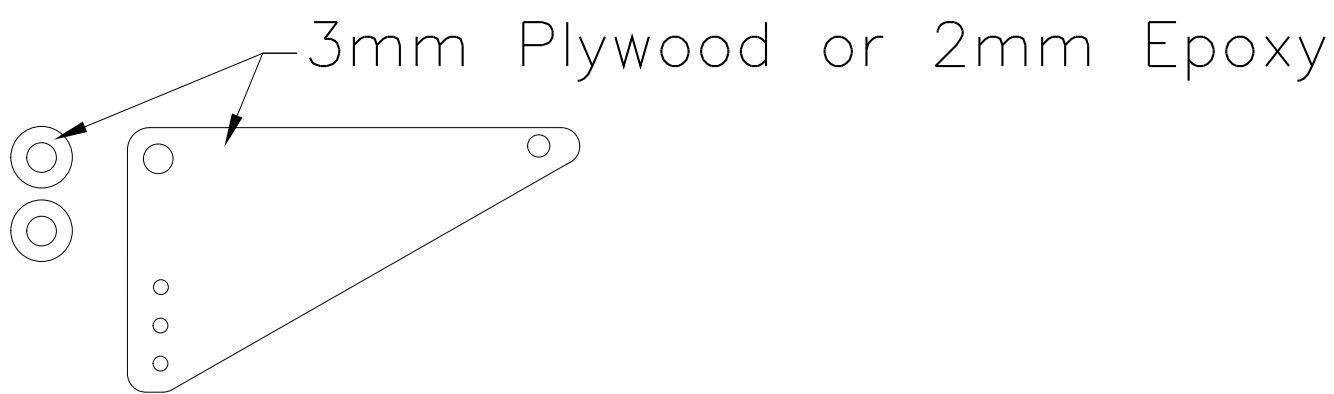

3mm Plywood or 2mm Epoxy

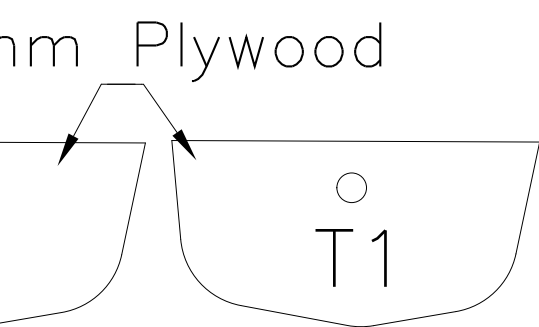

3mm Plywood

T1

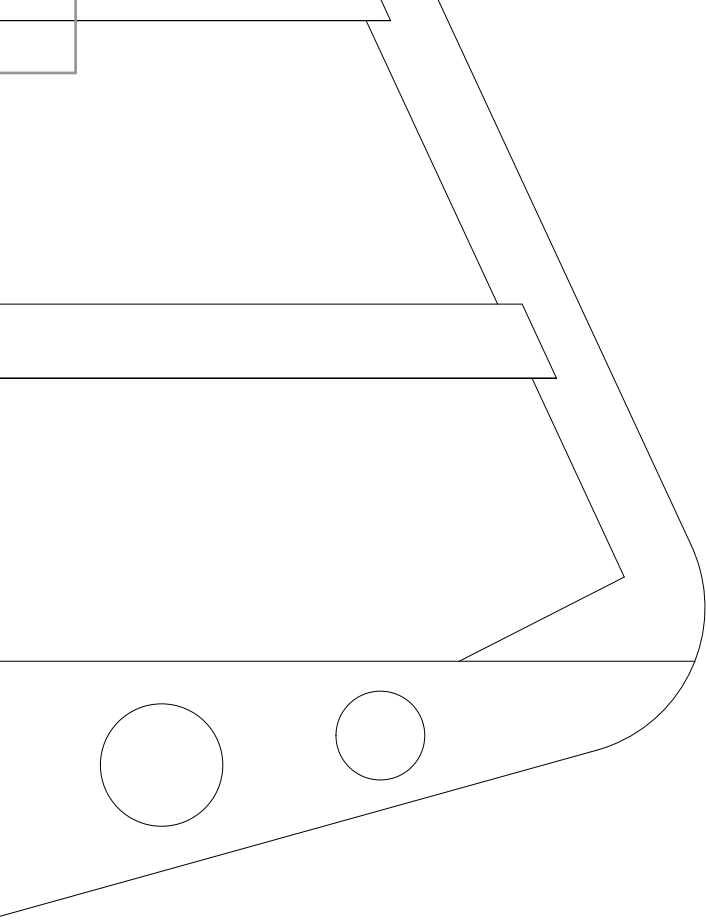

xy

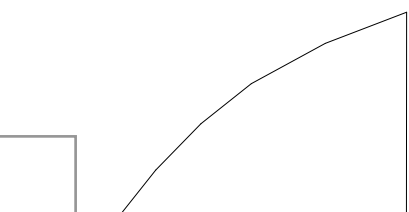

QUAR

Aerobatic glider

K]b[gdUb. ' &a

@Yb[\h ' %"(a

K]b['dfcZ]`Y. 'G6- *J '!G6- *J G

fMŁ: fYX 'A Uf]Y '#; `]XYf=fY`UbX"bYh!'Bc 'fYdfcXi Wh]cb'k]h\c

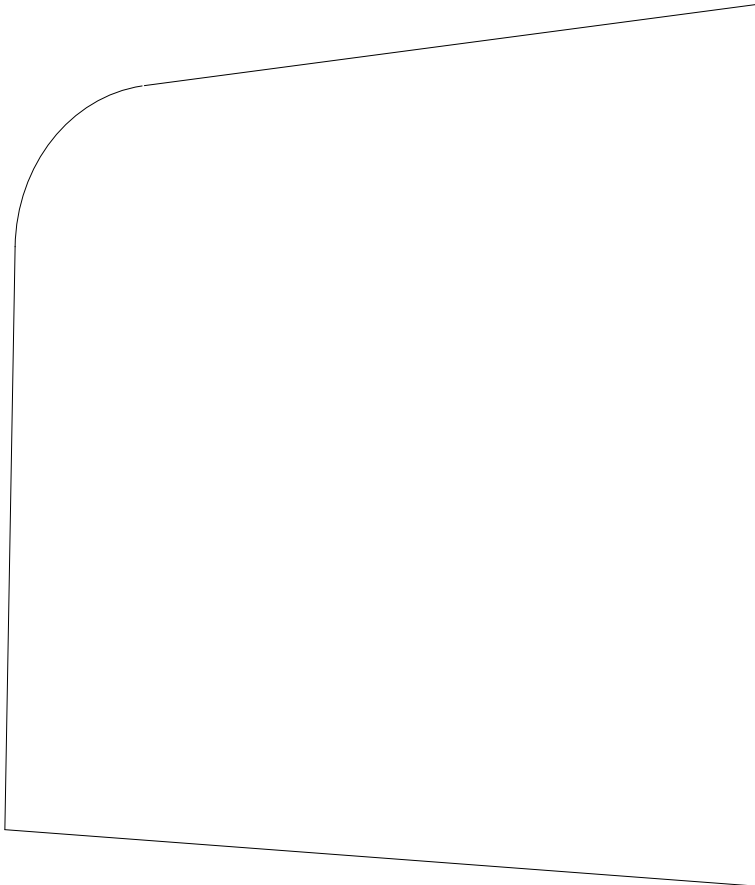

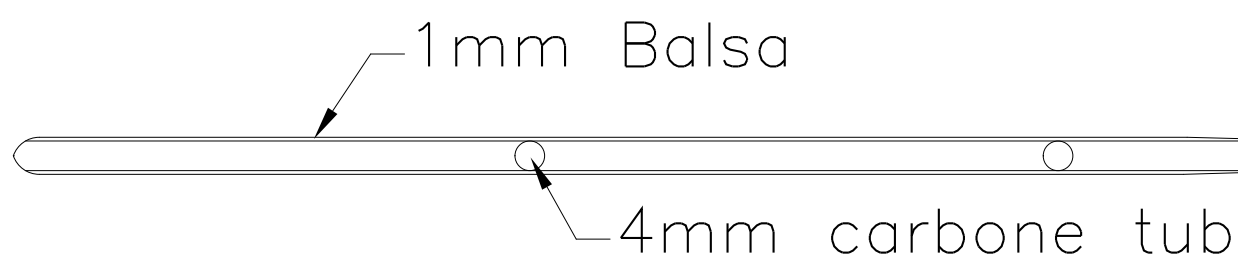

Removable Canopy

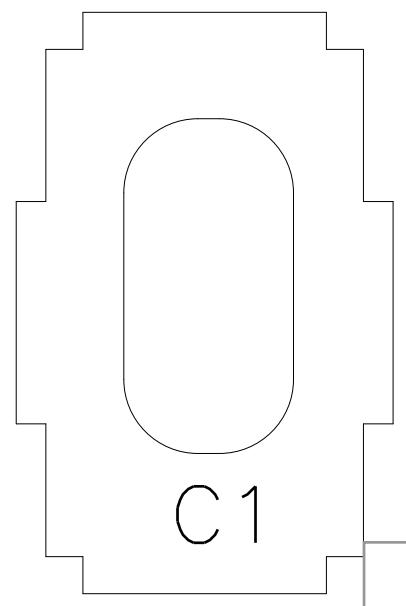
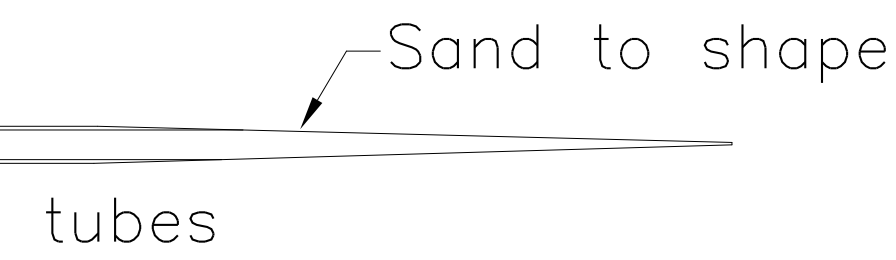
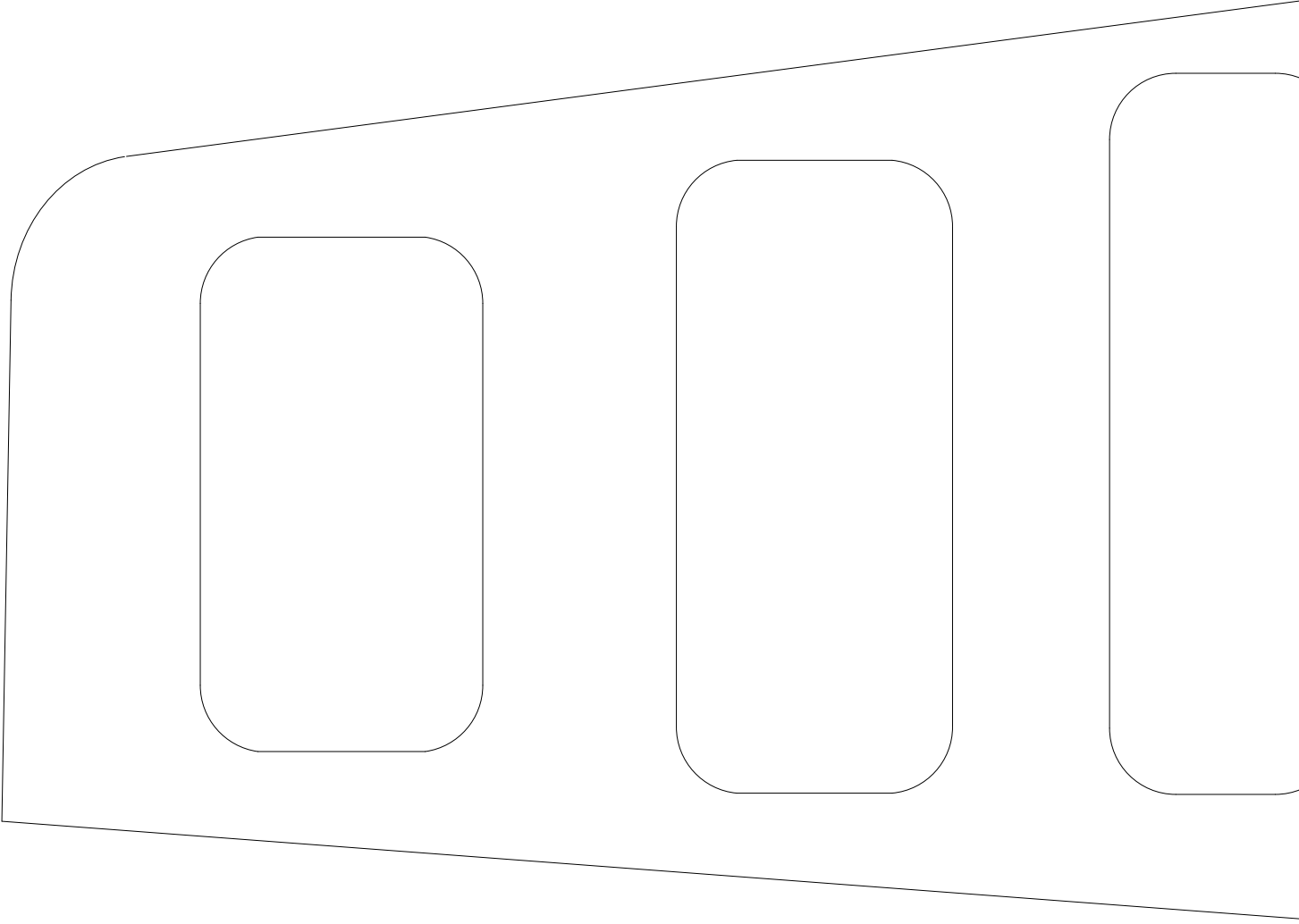

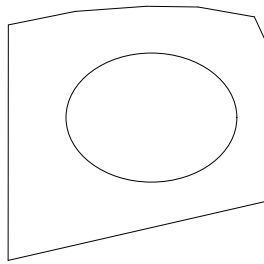
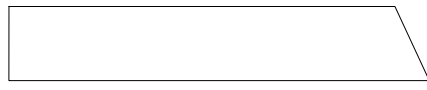

ALL rudd

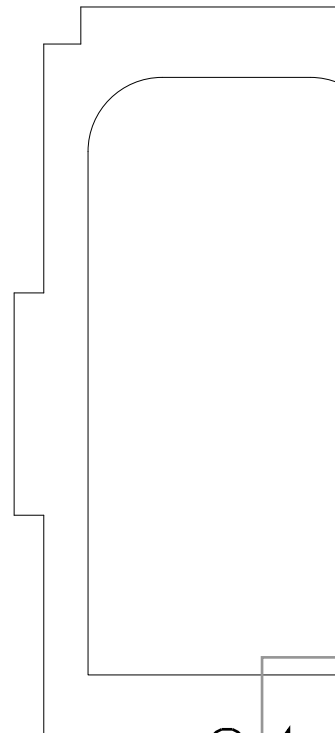
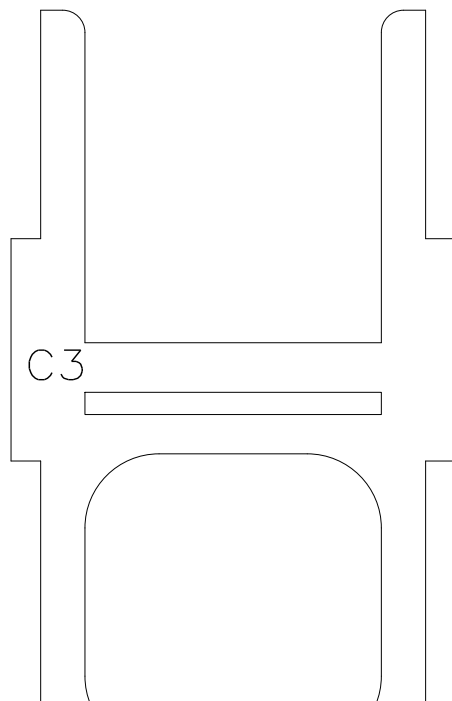
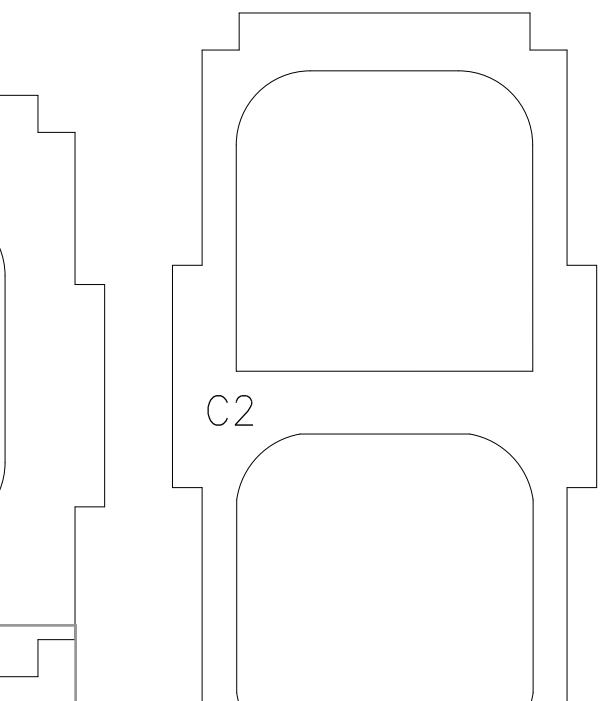

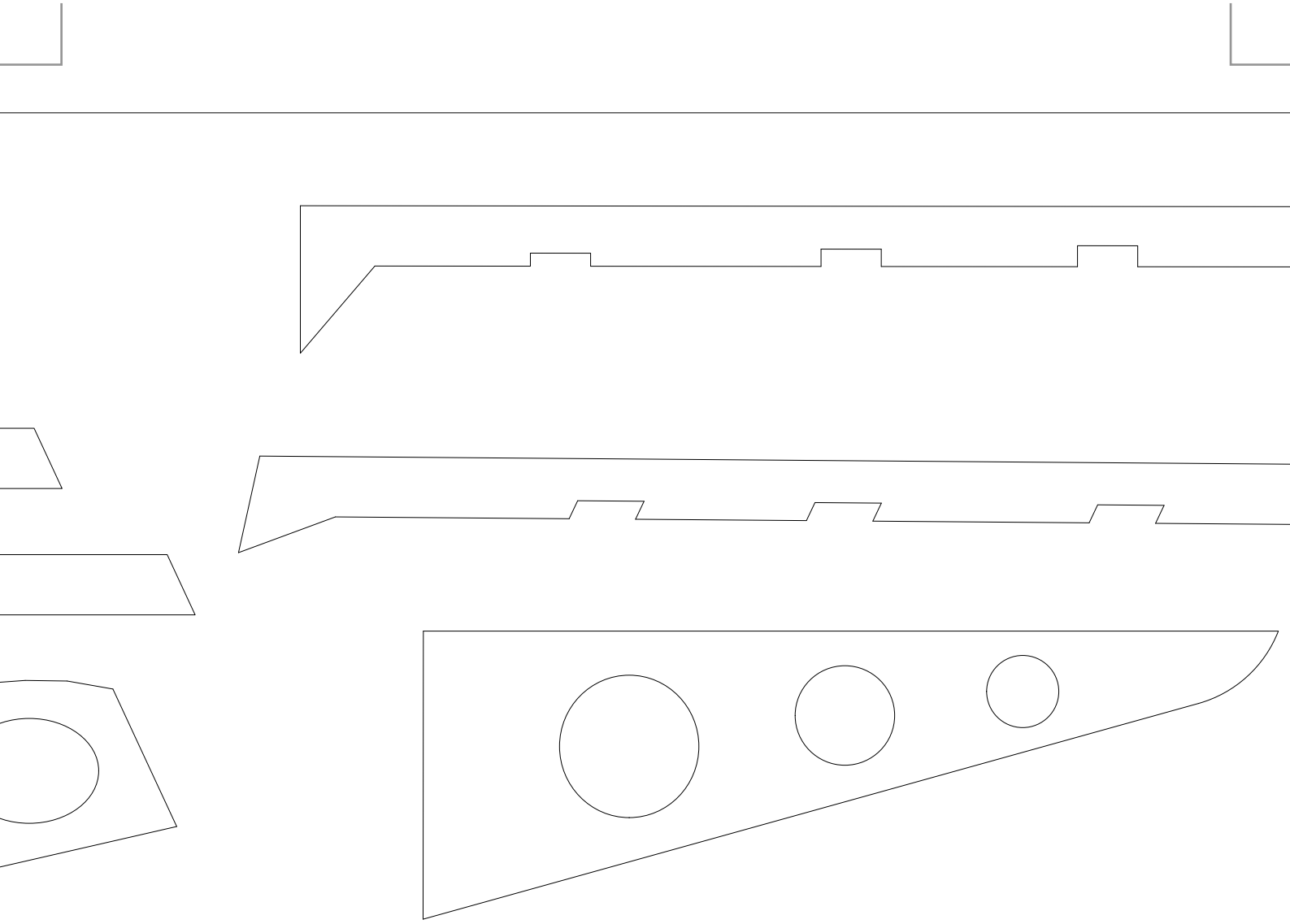

rudder parts in 5mm Balsa

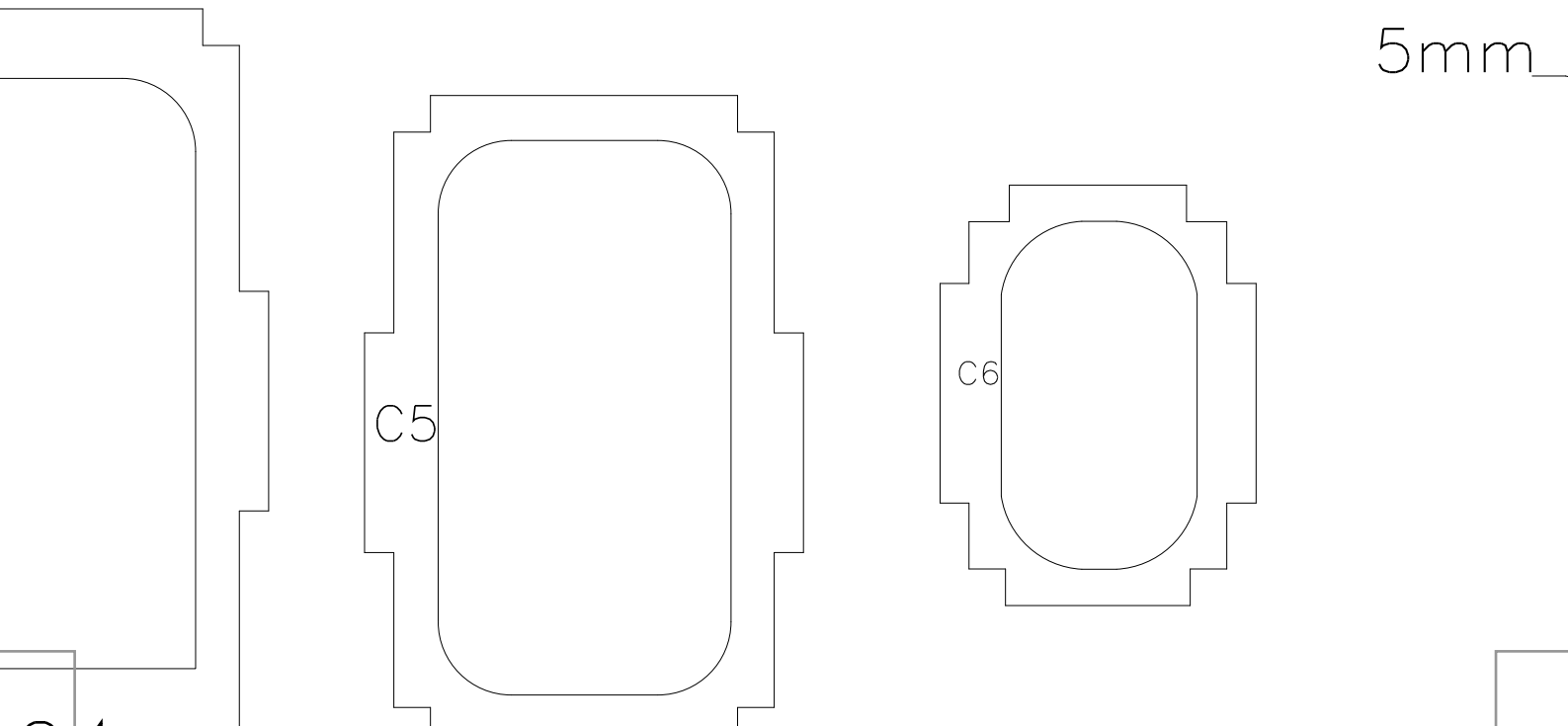

mm_Balsa

